









# F601



**Clamp multimeter**

# CONTENTS

<b>1</b>	<b>PRESENTATION</b> .....	<b>7</b>
1.1	THE SWITCH.....	8
1.2	THE KEYS OF THE KEYPAD.....	9
1.3	THE DISPLAY UNIT.....	10
1.3.1	<i>The symbols of the display unit</i> .....	11
1.3.2	<i>Measurement capacity exceeded (O.L.)</i> .....	11
1.4	THE TERMINALS.....	12
<b>2</b>	<b>THE KEYS</b> .....	<b>13</b>
2.1	 KEY.....	13
2.2	 KEY (SECOND FUNCTION).....	14
2.3	 KEY.....	14
2.4	 KEY.....	15
2.4.1	<i>In the normal mode</i> .....	15
2.4.2	<i>The MAX/MIN mode + activation of the HOLD mode</i> .....	15
2.4.3	<i>Access to the True-INRUSH mode (  set to  )</i> .....	16
2.5	 KEY.....	17
2.5.1	<i>The Hz function in the normal model</i> .....	17
2.5.2	<i>The Hz function + activation of the HOLD mode</i> .....	17
<b>3</b>	<b>USE</b> .....	<b>18</b>
3.1	COMMISSIONING.....	18
3.2	STARTING UP THE CLAMP MULTIMETER.....	18
3.3	SWITCHING THE CLAMP MULTIMETER.....	19
3.4	CONFIGURATION.....	19
3.4.1	<i>Programming of the maximum resistance allowed for a continuity</i> .....	19
3.4.2	<i>De-activation of automatic switching off (Auto Power OFF)</i> .....	19
3.4.3	<i>Programming of the current threshold for the True INRUSH measurement</i>	20
3.4.4	<i>Change of temperature measurement unit</i> .....	20
3.4.5	<i>Default configuration</i> .....	21
3.5	VOLTAGE MEASUREMENT (V).....	21
3.6	CONTINUITY TEST  .....	22
3.6.1	<i>Automatic compensation of the resistance of the leads</i> .....	22
3.7	RESISTANCE MEASUREMENT $\Omega$ .....	23
3.8	DIODE TEST  .....	23
3.9	CURRENT MEASUREMENT (A).....	24
3.9.1	<i>AC measurement</i> .....	24
3.10	STARTING CURRENT OR OVERCURRENT (TRUE INRUSH) MEASUREMENT	











3.11	FREQUENCY MEASUREMENT (Hz) .....	25
3.11.1	<i>Frequency measurement in voltage</i> .....	25
3.11.2	<i>Frequency measurement in current</i> .....	26
3.12	TEMPERATURE MEASUREMENT .....	27
3.12.1	<i>Measurement without external sensor</i> .....	27
3.12.2	<i>Measurement with external sensor</i> .....	27
<b>4</b>	<b>CHARACTERISTICS</b> .....	<b>28</b>
4.1	REFERENCE CONDITIONS .....	28
4.2	CHARACTERISTICS UNDER THE REFERENCE CONDITIONS.....	28
4.2.1	<i>DC voltage measurement</i> .....	28
4.2.2	<i>AC voltage measurement</i> .....	29
4.2.3	<i>AC current measurement</i> .....	29
4.2.4	<i>True-Inrush measurement</i> .....	30
4.2.5	<i>Continuity measurement</i> .....	30
4.2.6	<i>Resistance measurement</i> .....	30
4.2.7	<i>Diode test</i> .....	31
4.2.8	<i>Frequency measurements</i> .....	31
4.2.9	<i>Temperature measurement</i> .....	32
4.3	ENVIRONMENTAL CONDITIONS .....	32
4.4	CHARACTERISTICS OF CONSTRUCTION .....	33
4.5	POWER SUPPLY .....	34
4.6	COMPLIANCE WITH INTERNATIONAL STANDARDS .....	34
4.7	VARIATIONS IN THE DOMAIN OF USE .....	35
<b>5</b>	<b>MAINTENANCE</b> .....	<b>36</b>
5.1	CLEANING.....	36
5.2	REPLACEMENT OF THE BATTERIES .....	36
<b>6</b>	<b>WARRANTY</b> .....	<b>37</b>
<b>7</b>	<b>DELIVERY CONDITION</b> .....	<b>37</b>

You have just acquired an **F601 clamp multimeter** and we thank you.

For best results from your device :

- **read** this user manual attentively,
- **observe** the precautions for its use.

### Meanings of the symbols used on the device

-  Danger. The operator agrees to refer to this data sheet whenever this danger symbol is encountered.
-  Application or withdrawal authorized on uninsulated or bare conductors at dangerous voltages.
-  1.5 V battery.
-  The CE marking indicates compliance with European directives.
-  Double insulation or reinforced insulation.
-  Selective sorting of wastes for the recycling of electrical and electronic equipment within the European Union.
-  In conformity with directive DEEE 2002/96/EC: this equipment must not be treated as household waste.
-  AC – Alternating current.
-  AC and DC – Alternating and direct current.
-  Earth.
-  Risk of electric shock.

## PRECAUTIONS FOR USE

---

This device complies with safety standards IEC-61010-1 and 61010-2-032 for voltages of 1,000V in category IV at an altitude OF less than 2000m, indoors, with a degree of pollution not exceeding 2.

These safety instructions are intended to ensure the safety of persons and proper operation of the device. If the tester is used other than as specified in this data sheet, the protection provided by the device may be impaired.

- The operator and/or the responsible authority must carefully read and clearly understand the various precautions to be taken in use.
- If you use this instrument other than as specified, the protection it provides may be compromised, thereby endangering you.
- Do not use the instrument in an explosive atmosphere or in the presence of flammable gases or fumes.
- Do not use the instrument on networks of which the voltage or category exceeds those mentioned.
- Do not exceed the rated maximum voltages and currents between terminals or with respect to earth.
- Do not use the instrument if it appears to be damaged, incomplete, or not properly closed.
- Before each use, check the condition of the insulation on the leads, housing, and accessories. Any element of which the insulation is deteriorated (even partially) must be set aside for repair or scrapped.
- Use leads and accessories rated for voltages and categories at least equal to those of the instrument. If not, an accessory of a lower category lowers the category of the combined Clamp + accessory to that of the accessory.
- Observe the environmental conditions of use.
- Do not modify the instrument and do not replace components with "equivalents". Repairs and adjustments must be done by approved qualified personnel.
- Replace the batteries as soon as the  symbol appears on the display unit. Disconnect all cords before opening the battery compartment cover.
- Use personal protective equipment when conditions require.
- Keep your hands away from the unused terminals of the instrument.
- When handling the test probes, crocodile clips, and clamp ammeters, keep your fingers behind the physical guard.

- As a safety measure, and to avoid repeated overloads on the inputs of the device, we recommend performing configuration operations only when the device is disconnected from all dangerous voltages.

## MEASUREMENT CATEGORIES

---

### Definitions of the measurement categories :

**CAT II:** Circuits directly connected to the low-voltage installation.

*Example: power supply to household electrical appliances and portable tools.*

**CAT III:** Power supply circuits in the installation of the building.

*Example: distribution panel, circuit-breakers, fixed industrial machines or devices.*

**CAT IV:** Circuits supplying the low-voltage installation of the building.

*Example: power lines, meters, and protection devices.*

# 1 PRESENTATION

The F601 is a professional electrical measuring instrument that combines the following functions:

- Current measurement;
- Measurement of inrush current / overcurrent (True-Inrush);
- Voltage measurement;
- Frequency measurement;
- Continuity test with buzzer;
- Resistance measurement;
- Diode test;
- Temperature measurement.

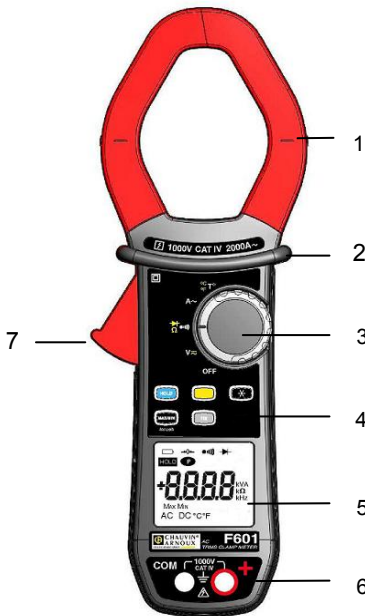

Item	Designation	See §
1	Jaws with centring marks (see connection principles)	<a href="#">3.5</a> to <a href="#">3.12</a>
2	Physical guard	-
3	Switch	<a href="#">1.1</a>
4	Function keys	<a href="#">2</a>
5	Display unit	<a href="#">1.3</a>
6	Terminals	<a href="#">1.4</a>
7	Trigger	-

Figure 1 : the F601 clamp multimeter

## 1.1 THE SWITCH

The switch has five positions. To access the  $V_{\sim}$ ,  $V_{\square}$ ,  $A_{\sim}$ ,  $\Omega$ ,  $\rightarrow$ ,  $\rightarrow$ , functions, set the switch to the desired function. Each setting is confirmed by an audible signal. The functions are described in the table below.

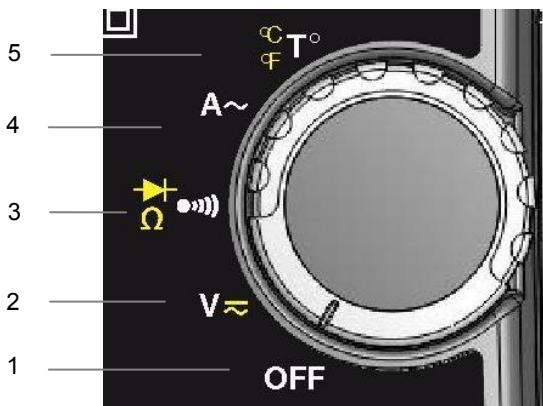

Figure 2 : the switch

Item	Function	See §
1	OFF mode – Switches the clamp multimeter off	<a href="#">3.3</a>
2	AC, DC voltage measurement (V)	<a href="#">3.5</a>
3	Continuity test $\bullet$ ))) Resistance measurement $\Omega$ Diode test $\rightarrow$	<a href="#">3.6</a> <a href="#">3.7</a> <a href="#">3.8</a>
4	AC current measurement (A)	<a href="#">3.9</a>
5	Temperature measurement ( $^{\circ}\text{C}/^{\circ}\text{F}$ )	<a href="#">3.12</a>



## 1.2 THE KEYS OF THE KEYPAD

Here are the five keys of the keypad :

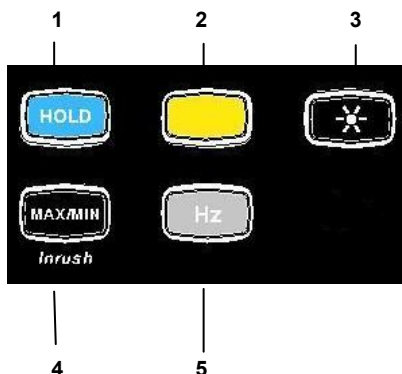
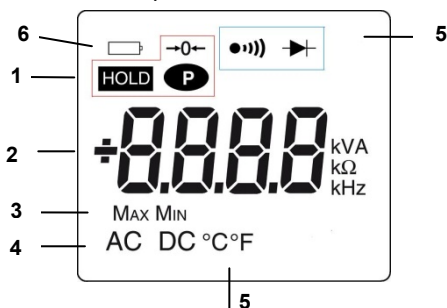

**Figure 3 : the keys of the keypad**

Item	Function	See §
1	Storage of values, disabling of display Compensation of the resistance of the leads in the continuity and ohmmeter function	<a href="#">2.1</a> <a href="#">3.6.1</a>
2	Selection of the type of measurement (AC, DC)	<a href="#">2.2</a>
3	Activation or de-activation of the backlighting of the display unit	<a href="#">2.3</a>
4	Activation or de-activation of the MAX/MIN mode Activation or de-activation of the INRUSH mode in A	<a href="#">2.4</a>
5	Frequency measurements (Hz)	<a href="#">2.5</a>

### 1.3 THE DISPLAY UNIT







Here is the display unit of the clamp multimeter:



**Figure 4 : the display unit**

Item	Function	See §
1	Display of the modes selected (keys)	<a href="#">2</a>
2	Display of the measurement value and unit	<a href="#">3.5</a> to <a href="#">3.12</a>
3	Display of the MAX/MIN modes	<a href="#">2.4</a>
4	Type of measurement (AC or DC)	<a href="#">2.2</a>
5	Display of the selected modes (switch)	<a href="#">3.5</a>
6	Spent battery indication	<a href="#">5.2</a>

### 1.3.1 The symbols of the display unit

Symbol	Designation
AC	Alternating current or voltage
DC	Direct voltage
	Storage of the values and hold of the display
Max	Maximum RMS value
Min	Minimum RMS value
V	Volt
Hz	Hertz
A	Ampere
$\Omega$	Ohm
m	Milli- prefix
k	Kilo- prefix
	Compensation of the resistance of the leads
	Continuity test
	Diode test
	Permanent display (automatic switching off de-activated)
	Spent battery indicator

### 1.3.2 Measurement capacity exceeded (O.L)

The O.L (Over Load) symbol is displayed when the display capacity is exceeded.

## 1.4 THE TERMINALS

The terminals are used as follows:

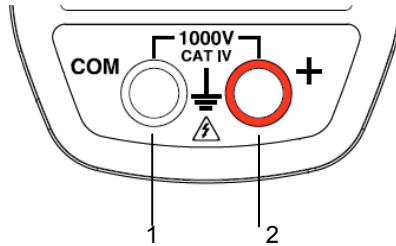

**Figure 5 : the terminals**

Item	Function
1	Cold terminal ( <b>COM</b> )
2	Hot terminal ( <b>+</b> )







## 2 THE KEYS



The keys of the keypad respond differently to short, long, and sustained presses. In this section, the  icon represents the possible positions of the switch for which the key concerned has some action.

### 2.1 KEY

This key is used to:

- store and look up the last values acquired specific to each function (V, A,  $\Omega$ , T°) according to the specific modes previously activated (MAX/MIN); the present display is then maintained while the detection and acquisition of new values continues;
- perform automatic compensation of the resistance of the leads (see also § [3.6.1](#));







Successive presses on 		... serve
	   	<ol style="list-style-type: none"> <li>1. to store the results of the present measurements</li> <li>2. to hold the display of the last value displayed</li> <li>3. to return to normal display mode (the value of each new measurement is displayed)</li> </ol>
Sustained		to perform automatic compensation of the resistance of the leads (see <a href="#">3.6.1</a> )

See also § [2.4.2](#) and § [2.5.2](#) for the action  key with the action of the  key and with the action of the  key.

## 2.2 KEY (SECOND FUNCTION)







This key is used to select the type of measurement (AC, DC) and the second functions marked in yellow next to the relevant positions of the switch. It can also be used in the configuration mode, to modify the default values (see §3.4)

**Remark:** the key is invalid in the MAX/MIN and HOLD modes.

Successive presses on 		... serve
		-to select AC or DC. Depending on your choice, the screen displays AC or DC
		-to cycle through the Ω and diode test  modes and to return to the continuity test 
		-to select °C or °F as the unit

## 2.3 KEY

This key is used to backlight the display unit.

Successive presses on 		... serve
	   	-to activate or de-activate the backlighting of the screen









**Remark:** the backlighting is switched off automatically at the end of 2 minutes.

## 2.4 KEY







### 2.4.1 In the normal mode

This key activates detection of the MAX and MIN values of the measurements made. Max and Min are the extreme mean values in DC and the extreme RMS values in AC.

*Remark* : in this mode, the "automatic switching off" function of the device is automatically de-activated. The  symbol is displayed on the screen.

Successive presses on 		... serve
short	  	-to activate detection of the MAX/MIN values -to display the MAX or MIN value successively -to return to display of the present measurement without exiting from the mode (the values already detected are not erased)  <i>Remark</i> : the MAX and MIN symbols are both displayed, but only the symbol of the quantity selected blinks.  Example: If MIN has been selected, MIN blinks and MAX is lit steadily.
long (> 2 sec)	   	to exit from the MAX/MIN mode. The values previously recorded are then erased.  <i>Remark</i> : if the HOLD function is activated, it is not possible to exit from the MAX/MIN mode. The HOLD function must first be de-activated.





### 2.4.2 The MAX/MIN mode + activation of the HOLD mode

Successive presses on 		... serve
short	   	to display successively the MAX/MIN values detected before the  key was pressed

Note: the HOLD function does not interrupt the acquisition of new MAX, MIN values.

### 2.4.3 Access to the True-INRUSH mode ( set to )

This key allows measurement of the True-Inrush current (starting current, or overcurrent in steady-state operation).

Successive presses on 		...serves
long (>2 sec)		<p><b>to enter</b> the True-INRUSH mode</p> <ul style="list-style-type: none"> <li>- "Inrh" is displayed for 3s (the backlighting blinks)</li> <li>- the triggering threshold is displayed for 5s (the backlighting is steady);</li> <li>- "-----" is displayed and the "A" symbol flashes</li> <li>- after detection and acquisition, the inrush current measurement is displayed, after the calculations stage "-----" (backlighting off)</li> </ul> <p><i>Remark:</i> the A symbol flashes to indicate "surveillance" of the signal.</p> <p><b>to exit</b> from the True-INRUSH mode (return to simple current measurement).</p>
short (<2 sec)  <i>Note:</i> a short press is functional only if an True-Inrush value has been detected.		<ul style="list-style-type: none"> <li>- to display the PEAK+ value of the current</li> <li>- to display the PEAK- value of the current</li> <li>- to display the RMS True-Inrush current</li> </ul> <p><i>Remark:</i> the A symbol is displayed steadily during this sequence.</p>







## 2.5 KEY





This key is used to display the frequency measurements of a signal.

**Remark** : this key is not working in DC mode.

### 2.5.1 The Hz function in the normal model

Successive presses on 		...serves
	 	to display: -the frequency of the signal measured -the present voltage (V) or current (A) measurement

### 2.5.2 The Hz function + activation of the HOLD mode

Successive presses on 		...serves
	 	-to store the frequency -to display successively the stored frequency, then the voltage or the current

## 3 USE

### 3.1 COMMISSIONING

Insert the batteries supplied with the device as follows:

1. Using a screwdriver, unscrew the screw of the battery compartment cover (item 1) on the back of the housing and open it.
2. Place the 4 batteries in the compartment (item 2), taking care to get the polarities right.
3. Close the battery compartment cover and screw it to the housing.

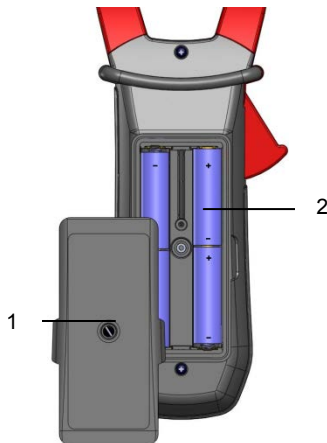

**Figure 6 : the battery compartment cover**

### 3.2 STARTING UP THE CLAMP MULTIMETER

The switch is set to OFF. Turn the switch to the function of your choice. The whole display lights (all symbols) for a few seconds (see §1.3), then the screen of the function chosen is displayed. The clamp multimeter is then ready to make measurements.

### 3.3 SWITCHING THE CLAMP MULTIMETER







The clamp multimeter can be switched off either manually, by setting the switch to OFF, or automatically, after ten minutes with no action on the switch and/or the keys. Thirty (30) seconds before the device is switched off, an audible signal sounds intermittently. To re-activate the device, press any key or turn the switch.

### 3.4 CONFIGURATION

As a safety measure, and to avoid repeated overloads on the inputs of the device, we recommend performing configuration operations only when the device is disconnected from all dangerous voltages.

#### 3.4.1 Programming of the maximum resistance allowed for a continuity



To program the maximum resistance allowed for a continuity

1. From the OFF position, hold the  key down while turning the switch to , until the "full screen" display ends and a beep is emitted, to enter the configuration mode. The display unit indicates the value below which the buzzer is activated and the  symbol is displayed. The value stored by default is 40Ω. The possible values lie between 1Ω and 999Ω.
2. To change the threshold, press the  key. The right-hand digit flashes: each press on the  key increments it. To shift to the next digit, apply a long press (>2s) to the  key.

To exit from the programming mode, turn the switch to another setting. The detection threshold chosen is stored (emission of a double beep).

#### 3.4.2 De-activation of automatic switching off (Auto Power OFF)

To de-activate automatic switching off:





In the OFF position, hold the  key down while turning the switch to , until the "full screen" display ends and a beep is emitted, to enter the configuration mode. The  symbol is displayed.

When the  key is released, the device is in the voltmeter function in the normal mode.

The return to Auto Power OFF takes place when the clamp is switched back on.

### 3.4.3 Programming of the current threshold for the True INRUSH measurement

To program the triggering current threshold of the True INRUSH measurement:



1. in the OFF position, hold the  key down while turning the switch to , until the "full screen" display ends and a beep is emitted, to enter the configuration mode. The display unit indicates the percentage overshoot to apply to the measured current to determine the measurement triggering threshold.  
The value stored by default is 10%, representing 110% of the established current measured. The possible values are 5%, 10%, 20%, 50%, 70%, 100%, 150%, and 200%.
2. To change the threshold, press the  key. The value flashes: each press on the  key displays the next value. To record the chosen threshold, apply a long press (>2s) on the  key. A confirmation beep is emitted.

To exit from the programming mode, turn the switch to another setting. The chosen threshold is stored (emission of a double beep).

Note: The starting (Inrush) current measurement triggering threshold is fixed at 1% of the least sensitive range. This threshold is not adjustable

### 3.4.4 Change of temperature measurement unit



To program the measurement unit, °C or °F:

1. In the OFF position, hold the  key down while turning the switch to , until the "full screen" display ends and a beep is emitted, to enter the configuration mode. The display unit indicates the existing unit (°C or °F). The default unit is °C.
2. Pressing the  key toggles between °C and °F.

When the desired unit is displayed, turn the switch to another setting. The unit chosen is stored (emission of a double beep).

### 3.4.5 Default configuration

To reset the clamp to its default parameters (factory configuration):

In the OFF position, hold the  key down while turning the switch to , until the "full screen" display ends and a beep is emitted, to enter the configuration mode. The "rSt" symbol is displayed.

After 2 s, the clamp emits a double beep, then all of the symbols of the screen are displayed until the  key is released. The default parameters are then restored:

Continuity detection threshold =40 $\Omega$

True Inrush triggering threshold =10%

Temperature measurement unit = $^{\circ}\text{C}$

### 3.5 VOLTAGE MEASUREMENT (V)

To measure a voltage, proceed as follows :

1. Set the switch to  ;
2. Connect the black lead to the COM terminal and the red lead to "+".
3. Place the test probes or the crocodile clips on the terminals of the circuit to be measured. The device selects AC or DC automatically according to which measured value is larger. The AC or DC symbol lights in blinking mode.

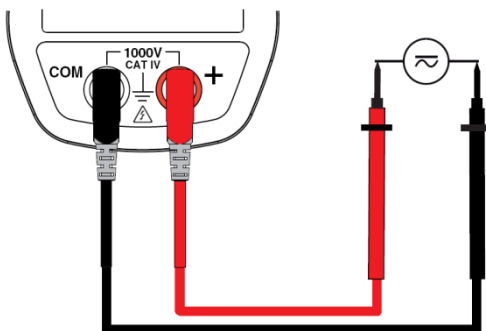

To select AC or DC manually, press the yellow key to reach the desired choice. The symbol corresponding to the choice made then lights in fixed mode.



The measured value is displayed on the screen.

### 3.6 CONTINUITY TEST

**Warning :** Before performing the test, make sure that the circuit is off and any capacitors have been discharged.

1. Set the switch to ; the  symbol is displayed ;
2. Connect the black lead to the COM terminal and the red lead to «+».
3. Place the test probes or the crocodile clips on the terminals of the circuit or component to be tested.

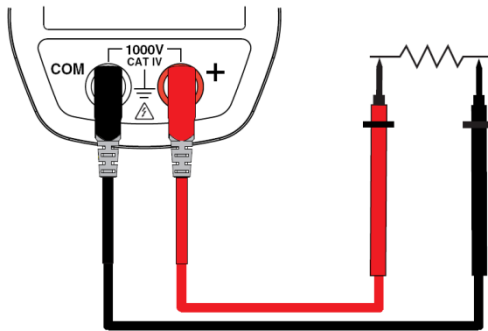

An audible signal is emitted if there is continuity, and the measured value is displayed on the screen.

#### 3.6.1 Automatic compensation of the resistance of the leads

**Warning :** before the compensation is executed, the MAX/MIN and HOLD modes must be de-activated.



To perform automatic compensation of the resistance of the leads, proceed as follows:

1. Short-circuit the leads connected to the device.
2. Hold the **HOLD** key down until the display unit indicates the lowest value. The device measures the resistance of the leads.
3. Release the **HOLD** key. The correction and the  $\rightarrow 0 \leftarrow$  symbole are displayed. The value displayed is stored.

**Remark :** the correction value is stored only if it is  $\leq 2 \Omega$ . Above  $2 \Omega$ , the value displayed blinks and is not stored.

### 3.7 RESISTANCE MEASUREMENT $\Omega$

**Warning :** Before making a resistance measurement, make sure that the circuit is cold and any capacitors have been discharged.

1. Set the switch to  and press the  key. The  $\Omega$  symbol is displayed;
2. Connect the black lead to the **COM** terminal and the red lead to « + »;
3. Place the test probes or the crocodile clips on the terminals of the circuit or component to be measured ;

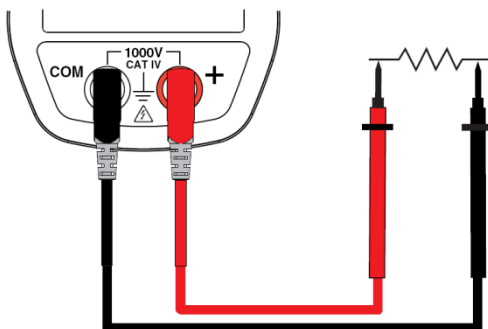



The measured value is displayed on the screen

**Remark :** to measure low resistance values, first carry out the compensation of the resistance of the leads (see § [3.6.1](#)).

### 3.8 DIODE TEST $\rightarrow|+$

**Warning:** Before performing the diode test, make sure that the circuit is cold and any capacitors have been discharged.

1. Set the switch to  and press the  key twice. The  $\rightarrow|+$  symbol is displayed.
2. Connect the black lead to the COM terminal and the red lead to «+».
3. Place the test probes or the crocodile clips on the terminals of the component to be tested.

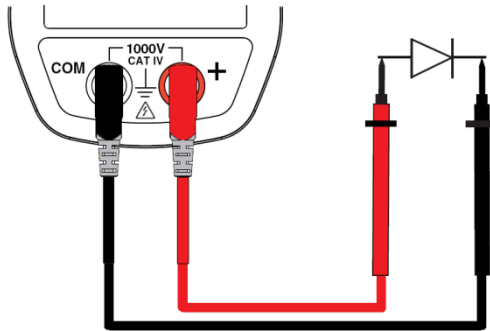

The measured value is displayed on the screen.

### 3.9 CURRENT MEASUREMENT (A)

The jaws are opened by pressing the trigger on the body of the device. The arrow on the jaws of the clamp (see the diagram below) must point in the presumed direction of flow of the current, from the generator to the load. Make sure that the jaws have closed correctly.

**Remark:** the measurement results are optimal when the conductor is centred in the jaws (aligned with the centring marks).

#### 3.9.1 AC measurement

For an AC current measurement, proceed as follows:

1. Set the switch to **A~**.
2. Encircle only the conductor concerned with the clamp ;

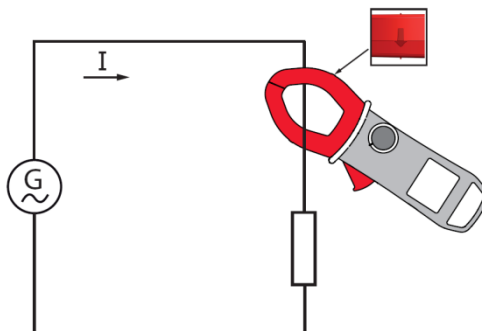



The measured value is displayed on the screen.



### 3.10 STARTING CURRENT OR OVERCURRENT (TRUE INRUSH) MEASUREMENT

To measure a starting current or overcurrent, proceed as follows:

1. Set the switch to  then encircle only the conductor concerned with the clamp.
2. Effect a long press on the  key. The InRh symbol is displayed, then the triggering threshold. The clamp then awaits detection of the True-Inrush current. "-----" is displayed and the "A" symbol flashes.
3. After detection and acquisition for 100 ms, the RMS value of the True-Inrush current is displayed, along with the PEAK+/PEAK- values subsequently.
4. A long press on the  key or a change of function leads to exiting from the True-Inrush mode.



**Remark :** the triggering threshold in A is 20A if the initial current is zero (starting of installation); it is that set in the configuration (see §[3.4.3](#)) for an established current (overload in a installation)..

### 3.11 FREQUENCY MEASUREMENT (HZ)

The frequency measurement is available in V and A for AC quantities. The measurement is based on a count of the passages of the signal through zero (positive-going edges).

#### 3.11.1 Frequency measurement in voltage

To measure the frequency in voltage, proceed as follows:

1. Set the switch to  and press the  key. The Hz symbol is displayed.
2. Select AC by pressing the yellow  key until the desired choice is reached.
3. Connect the black lead to the COM terminal and the red lead to "+".
4. Place the test probes or the crocodile clips on the terminals of the circuit to be measured.

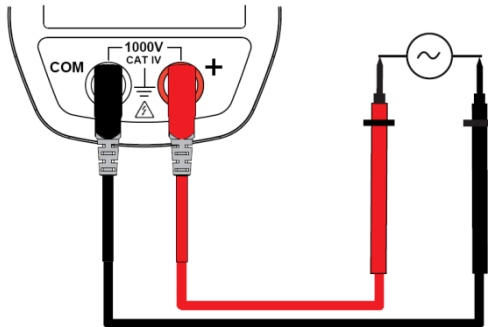

The measured value is displayed on the screen.

### 3.11.2 Frequency measurement in current

1. Set the switch to **A~** and press the **Hz** key. The Hz symbol is displayed.
2. Encircle only the conductor concerned with the clamp.

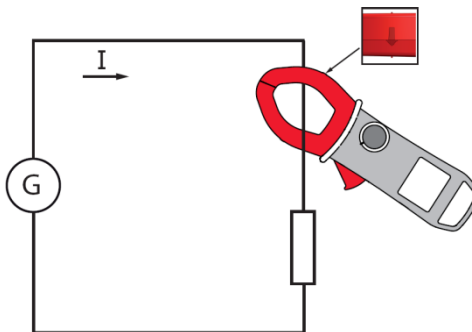

The measured value is displayed on the screen.

## 3.12 TEMPERATURE MEASUREMENT

### 3.12.1 Measurement without external sensor

1. Set the switch to .

The temperature displayed (blinking) is the internal temperature of the device, equal to the ambient temperature after a sufficiently long thermal stabilization time (at least one hour).

### 3.12.2 Measurement with external sensor

The device measures the temperature using a K thermocouple.

1. Connect the K thermocouple to the + and COM input terminals of the device.
2. Set the switch to .
3. Place the K thermocouple on the element or zone to be measured, which must not be at a dangerous voltage.

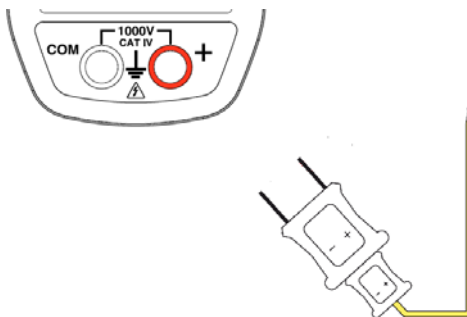

The temperature is displayed on the screen.

To change the unit, °F or °C, press the  key.

#### **Remarks :**

- If the external sensor is defective, the temperature displayed blinks.
- If there are large variations of the environment of the device, the measurement must be preceded by a stabilization time.

## 4 CHARACTERISTICS

### 4.1 REFERENCE CONDITIONS

Quantities of influence	Reference conditions
Temperature	23°C ±2°C
Relative humidity	45% to 75%
Supply voltage	6.0V ±0.5V
Frequency range of the applied signal	45–65Hz
Sine wave	pure
Peak factor of the applied alternating signal	$\sqrt{2}$
Position of the conductor in the clamp	centred
Adjacent conductors	none
Alternating magnetic field	none
Electric field	none

### 4.2 CHARACTERISTICS UNDER THE REFERENCE CONDITIONS

The uncertainties are expressed in  $\pm$  (x% of the reading (R) + y points (pt)).

#### 4.2.1 DC voltage measurement

Measurement range	0.00 V to 99.99 V	100.0 V to 999.9 V	1000 V (1)
Specified measurement range	0 to 100% of the measurement range		
Uncertainties	from 0.00V to 9.99V $\pm(1\% R + 10 \text{ pt})$ from 10.00V to 99.99V $\pm(1\% R + 3 \text{ pt})$	$\pm(1\% R + 3 \text{ pt})$	
Resolution	0.01V	0.1V	1V
Input impedance	10M $\Omega$		

**Note (1)** Above 1000V, a repetitive beep indicates that the voltage being measured is greater than the safety voltage for which the device is guaranteed.

## 4.2.2 AC voltage measurement

Measurement range	0.15 V to 99.99 V	100.0 V to 999.9 V	1000 V RMS 1400 V peak (1)
Specified measurement range (2)	0 to 100% of the measurement range		
Uncertainties	from 0.15V to 9.99V ± (1% R + 10 pt) from 10.00V to 99.99V ± (1% R + 3 pt)	± (1% R + 3 pt)	
Resolution	0.01V	0.1V	1V
Input impedance	10MΩ		

**Note (1)** Above 1000V, a repetitive beep indicates that the voltage being measured is greater than the safety voltage for which the device is guaranteed.

Bandwidth in AC = 3 kHz

**Note (2)** Any value between zero and the min. threshold of the measurement range (0.15V) is forced to "----" on the display

**Specific characteristics in MAX/MIN mode** (from 10Hz to 1kHz in AC, from 0.30V) :

- Uncertainties: add 1% L to the values of the table above.
- Capture time of the extrema: approximately 100ms.

## 4.2.3 AC current measurement

Measurement range (2)	0.15 A to 99.99 A	100.0 A to 999.9 A	1000 A to 2000 A (1)
Specified measurement range	0 to 100% of the measurement range		
Uncertainties	± (1% R + 10 pt)	± (1% R + 3 pt)	± (1,5% R + 3 pt)
Resolution	0.01A	0.1A	1A

**Note (1)** Above 2000 A, the display indicate "OL".

Bandwidth in AC = 1 kHz

**Note (2)** Any value between zero and the min. threshold of the measurement range (0.15A) is forced to "----" on the display.

Residual current at zero <150mA.

**Specific characteristics in MAX/MIN mode** (from 10Hz to 1kHz in AC, from 0,30A):

- Uncertainties: add 1% L to the values of the table above.
- Capture time of the extrema: approximately 100ms.

#### 4.2.4 True-Inrush measurement

Measurement range	20 A to 2000 A AC
Specified measurement range	0 to 100% of the measurement range
Uncertainties	$\pm (5\% R + 5 \text{ pt})$
Resolution	1 A

**Specific characteristics in PEAK mode in True-Inrush** (from 10Hz to 1 kHz in AC):

- Uncertainties: add  $\pm (1.5\% L + 0.5A)$  to the values in the tables above.
- PEAK capture time: 1ms min. to 1.5ms max.

#### 4.2.5 Continuity measurement

Measurement range	0.0 $\Omega$ to 999.9 $\Omega$
Open-circuit voltage	$\leq 3,6 \text{ V}$
Measurement current	550 $\mu\text{A}$
Uncertainties	$\pm (1\% R + 5 \text{ pt})$
Buzzer triggering threshold	Adjustable from 1 $\Omega$ to 999 $\Omega$ (40 $\Omega$ is the default)

#### 4.2.6 Resistance measurement

Measurement range (1)	0.0 $\Omega$ to 59.9 $\Omega$	60.0 $\Omega$ to 599.9 $\Omega$	600 $\Omega$ to 5999 $\Omega$	6.00 k $\Omega$ to 59.99 k $\Omega$
Specified measurement range	1 to 100% of the measurement range		0 to 100% of the measurement range	
Uncertainties	$\pm (1\% R + 10 \text{ pt})$	$\pm (1\% R + 5 \text{ pt})$		
Resolution	0.1 $\Omega$		1 $\Omega$	10 $\Omega$
Open-circuit voltage	$\leq 3.6 \text{ V}$			
Measurement current	550 $\mu\text{A}$		100 $\mu\text{A}$	10 $\mu\text{A}$

**Note (1)** Above the maximum display value, the display unit indicates "OL".  
The "-" and "+" signs are not managed.

**Specific characteristics in MAX/MIN mode:**

- Uncertainties: add 1% R to the values of the table above.
- Capture time of the extrema: approximately 100ms.

## 4.2.7 Diode test

Measurement range	0.000 V to 3.199 V DC
Specified measurement range	1 to 100% of the measurement range
Uncertainties	$\pm (1\% R + 10 \text{ pt})$
Resolution	0.001V
Measurement current	0,55 mA
Indication: junction reversed or open-circuit	Display of "OL" when the measured voltage >3.199V

 **Note** : The "-" sign is disabled for the diode test function.

## 4.2.8 Frequency measurements

### 4.2.8.1 Characteristics in voltage

Measurement range (1)	5.0 Hz to 999.9 Hz	1000 Hz to 9999 Hz	10.00 kHz to 19.99 kHz
Specified measurement range	1 to 100% of the measurement range	0 to 100% of the measurement range	
Uncertainties	$\pm (0.4\% R + 1 \text{ pt})$		
Resolution	0.1 Hz	1 Hz	10 Hz

### 4.2.8.2 Characteristics in current

Measurement range (1)	5.0 Hz to 999.9 Hz
Specified measurement range	1 to 100% of the measurement range
Uncertainties	$\pm (0.4\% R + 1 \text{ pt})$
Resolution	0.1Hz

**Note (1)** - If the level of the signal is too low ( $U < 3V$  or  $I < 3A$ ) or if the frequency is less than 5Hz, the device cannot determine the frequency and displays dashes "----"

**Specific characteristics in MAX/MIN mode MAX-MIN** (from 10Hz to 5kHz in voltage and from 10Hz to 1kHz in current):

- Uncertainties: add 1% R to the values of the table above.
- Capture time of the extrema: approximately 100ms.

#### 4.2.9 Temperature measurement

Function	External temperature	
Type of sensor	K thermocouple	
Operating range	-60.0°C to +999.9°C -76.0°F to +1,831.8°F	+1,000°C to +1,200°C +1,832°F to +2,192°F
Specified measurement range	1 to 100% of the measurement range	0 to 100% of the measurement range
Uncertainties (1)	1% R $\pm$ 3°C 1% R $\pm$ 5.4°F	1% R $\pm$ 3°C 1% R $\pm$ 5.4°F
Resolution	0.1°C 0.1°F	1°C 1°F

**Note (1)** The stated external temperature measurement accuracy does not take the accuracy of the K thermocouple into account.

**Note 2** use of the thermal time constant (0.7min/°C):

If there is a sudden variation of the temperature of the clamp, by 10°C for example, the clamp will be at 99% (cnst= 5) of the final temperature after 0.7min/°C $\times$ 10°C $\times$ 5= 35 min (to which must be added the constant of the external sensor).

#### Specific characteristics in MAX/MIN mode :

- Uncertainties: add 1% R to the values of the table above.
- Capture time of the extrema: approximately 100ms.

#### 4.3 ENVIRONMENTAL CONDITIONS

Environmental conditions	in use	in storage
Temperature	-20 C to + 55 C	-40 °C to + 70°C
Relative humidity (RH)	$\leq$ 90% at 55°C	$\leq$ 90% up to 70° C



#### 4.4 CHARACTERISTICS OF CONSTRUCTION

Housing	Rigid polycarbonate shell with moulded elastomer covering
Jaws	Polycarbonate Opening: 60 mm Clamping diameter: 60 mm
Screen	LCD display unit Blue backlighting Dimension: 41 x 48 mm
Dimension	H-296 x W-111 x D-41mm
Weight	640g (with the batteries)

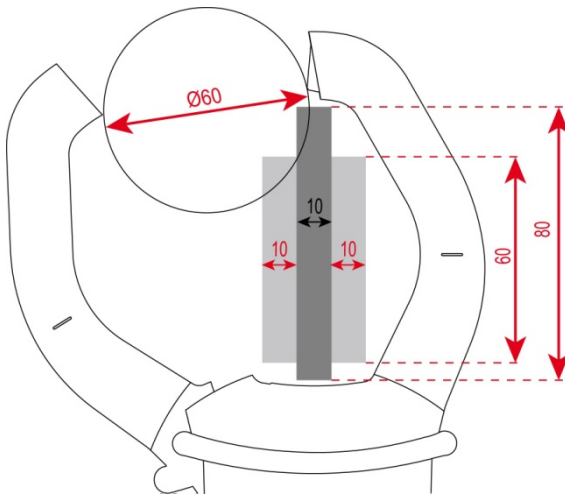

#### 4.5 POWER SUPPLY

Batteries	4x1,5V LR6
Mean life	>350 hours (without backlighting)
Duration of operation before automatic switching off	After 10 minutes without action on the switch and/or keys

#### 4.6 COMPLIANCE WITH INTERNATIONAL STANDARDS

Electric safety	Compliant with standards IEC-61010-1, IEC-61010-2-30, and IEC-61010-2-32: 1000V CAT-IV.
Electromagnetic compatibility	Compliant with standard EN-61326-1 Classification: residential environment
Mechanical strength	Free fall: 2m (in accordance with standard IEC-68-2-32)
Level of protection of the housing	Housing: IP54 (per standard IEC-60529) Jaws: IP40

## 4.7 VARIATIONS IN THE DOMAIN OF USE

Quantity of influence	Range of influence	Quantity influenced	Influence	
			Typical	MAX
Temperature	-20...+55°C	V AC V DC A * T °C Hz Ω 	- 0,1%R/10°C 1%R/10°C * (0,2%R+1°C)/10°C 0,1%R/10°C + 2ct	0,1%R/10°C 0,5%R/10°C + 2 ct 1,5%R/10°C + 2ct * (0,3%R+2°C)/10°C 0,1%R/10°C + 3ct
Humidity	10%...90%RH	V A	0.1%R	0.1%R + 1 ct
Frequency	10Hz...1kHz 1kHz...3kHz 10Hz...400Hz 400Hz...1kHz	V A	1%R 8%R 1%R 4%R	1%R + 1 ct 9%R + 1 ct 1%R + 1 ct 5%R + 1 ct
Position of the conductor in the jaws (f≤400Hz)	Any position on the internal perimeter of the jaws	A (< 2000A DC or 1400A AC) (>2000A DC)	2%R 8%R	4%R + 1 ct
Adjacent conductor carrying a current of 150 A DC or RMS	Conductor touching the external perimeter of the jaws	A	42 dB	35 dB
Conductor enclosed by the clamp	0-500 A RMS	V	< 1 ct	1 ct
Application of a voltage on the clamp	0-1000V DC or RMS	A	< 1 ct	3% R + 1 ct
peak factor	1.4 to 3.5, limited to 3000 A peak 1400V peak	A (AC) V (AC)	1%R 1%R	3% R + 1 ct

Note \* in Temperature : Influence specified until 1000 A

## 5 MAINTENANCE

---

The instrument has no parts that can be replaced by personnel who are not trained and approved. Any non-approved repair or other work, or replacement of a part by an "equivalent", may severely compromise safety.

### 5.1 CLEANING

- Disconnect everything connected to the device and set the switch to OFF.
- Use a soft cloth moistened with soapy water. Rinse with a damp cloth and dry quickly using a dry cloth or forced air.
- Dry perfectly before putting back into use.

### 5.2 REPLACEMENT OF THE BATTERIES

The  symbol indicates that the batteries are spent. When this symbol appears on the display unit, the batteries must be replaced. The measurements and specifications are no longer guaranteed.

To replace the batteries, proceed as follows:

1. Disconnect the measurement leads from the input terminals.
2. Set the switch to OFF.
3. Use a screwdriver to unscrew the screw securing the battery compartment cover to the back of the housing and open the cover (see [§3.1](#)).
4. Replace all of the batteries (see [§3.1](#)).
5. Close the cover and screw it to the housing.

## 6 WARRANTY

---

Except as otherwise stipulated, our warranty is valid for three years starting from the date on which the equipment was sold. Extract from our General Conditions of Sale provided on request.

The warranty does not apply in the following cases:

- Inappropriate use of the equipment or use with incompatible equipment;
- Modifications made to the equipment without the explicit permission of the manufacturer's technical staff;
- Work done on the device by a person not approved by the manufacturer;
- Adaptation to a particular application not anticipated in the definition of the equipment or not indicated in the user's manual;
- Damage caused by shocks, falls, or floods.

## 7 DELIVERY CONDITION

---

The **F601** clamp multimeter is delivered in its packaging box with :

- 2 banana-banana leads, one red and one black
- 2 test probes, one red and one black
- 1 K thermocouple with banana terminations
- 4 1.5V batteries
- 1 carrying bag
- 1 multilingual user guide on a mini-CD
- 1 multilingual getting started guide

For accessories and spares, visit our web site:

[www.chauvin-arnoux.com](http://www.chauvin-arnoux.com)

---

**FRANCE**

**Chauvin Arnoux Group**

190, rue Championnet

75876 PARIS Cedex 18

Tél : +33 1 44 85 44 85

Fax : +33 1 46 27 73 89

info@chauvin-arnoux.com

www.chauvin-arnoux.com

**INTERNATIONAL**

**Chauvin Arnoux Group**

Tél : +33 1 44 85 44 38

Fax : +33 1 46 27 95 69

**Our international contacts**

[www.chauvin-arnoux.com/contacts](http://www.chauvin-arnoux.com/contacts)

